

GHBG Series

GHBG 010 36 3R6

Technical datasheet



Goorui blower performance curves

Vacuum selection diagram curve

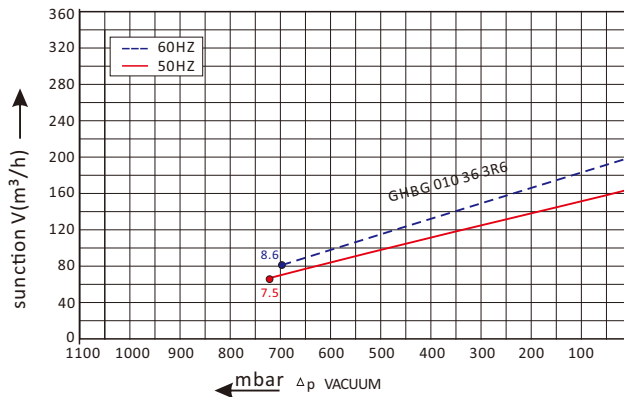

Compressor selection diagram curve

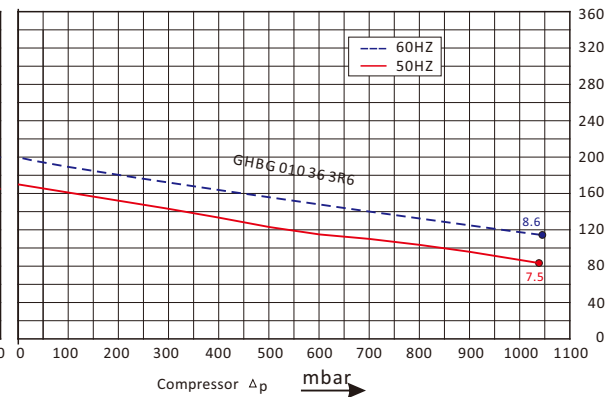

Goorui blower installation drawing

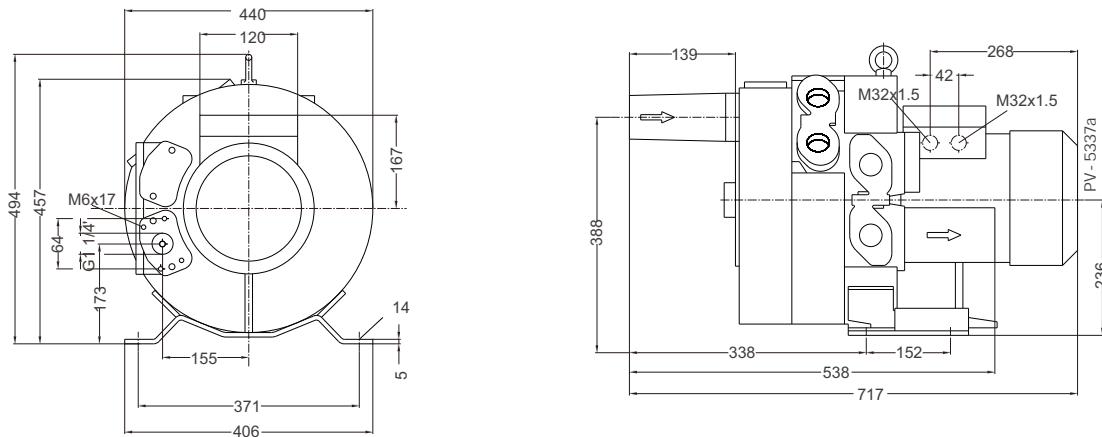

Goorui blower parameter

Model	Frequency	Output	voltage	Current	airflow	pressure		noise	Weight
						vacuum	compressor		
	HZ	KW	V	A	m ³ /h	mbar	mbar	dB(A)	kg
3~ 50/60Hz IP54 INSULATION class F									
GHBG 010 36 3R6	50	7.5	345-415 Δ/600-720Y	16.7 Δ/9.6Y	170	-730	1040	72	85
GHBG 010 36 3R6	60	8.6	380-480 Δ/660-720Y	17.3 Δ/10.0Y	200	-700	1040	76	85

The performance curves of Goorui blower is tested through below ways:

Under one atmospheric pressure, suck 15°C air and then you can calculate the data, of course allow 10% difference, and when the sucked air and surroundings temperature are not higher than 25°C, you still can get total pressure difference as the curves shows.